



Competence in lime



GEBR. PFEIFFER
Progress is our tradition



GEBR. PFEIFFER

GEBR. PFEIFFER

Progress is our tradition

Gebr. Pfeiffer looks back on a long and successful history that is based on high-quality products, closeness to the customer and an international standing. Even in an environment undergoing fast changes we remain loyal to these standards. That is why our company and its employees will shape the future.

Since our foundation in 1864 we have always participated in the development of modern process technology for grinding, separating, drying, hydrating and calcining.

With more than 450 employees, our center of competence in Kaiserslautern as well as our subsidiaries in the United States and India are active all over the world, supported by an extensive network of cooperations and representations.



Our success is the result of a wide product range, a modern test station, in-house workshops with a high vertical capacity and an extensive store of

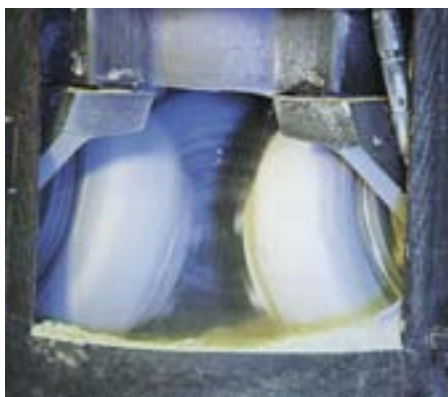

experience especially with the cement, lime, gypsum and ceramics industries.

We regard the finding of innovative, customized systems that meet your special requirements as our most important task.

We ensure a long service life for our plants and machines by establishing long-lasting cooperations in a spirit of partnership to the benefit of a high-quality finished product, safe plant operation, economic viability and technical progress.



hot gas area of an MPS mill

Lime - a market with a future

Lime is one of the major basic materials. As a collective term it refers not only to natural limes (CaCO_3) and quicklimes (CaO) but also to hydrated limes (Ca(OH)_2). Lime is a highly versatile material. Quite a number of everyday products are inconceivable without lime. The main lime applications are in the iron and steel industry, the chemical industry, the building materials industry and the building trade, the conservation of the environment in terms of fresh water conditioning, waste water treatment and air pollution abatement, as well as in farming and forestry.



There are various processing methods to make lime suitable for practical use. We plan and manufacture both complete processing plants and individual machines for you. We help you to choose equipment ideally suited for your special requirement from our extensive manufacturing program.

The history of our company is closely connected with the history of the lime industry. The lime industry relies on us! Hundreds of Pfeiffer lime processing plants are in operation in more than 50 countries all over the world.

Our competence

- grinding
- drying
- separating
- hydrating

The Pfeiffer machine program

- **The PFEIFFER MPS vertical roller mill** 9
ideal for combined grinding and drying, perfectly suited for the processing of relatively coarse feed sizes
- **The PFEIFFER MRD ball mill**..... 11
ideal for the fine-grinding of hydrate grits
- **The PFEIFFER distribution table air separators**.. 13
type SUT – with a constant speed
type SUV – with a variable speed
- **The PFEIFFER high-efficiency separator**..... 13
type SLV – with a variable speed
- **The PFEIFFER lime hydrating machines**..... 15
designed either as a one-stage machine or as a multi-stage machine with wet scrubber or filter
- **The PFEIFFER TRT Triplex dryer**..... 17
the space-saving dryer for limestone of all usual grain sizes

1

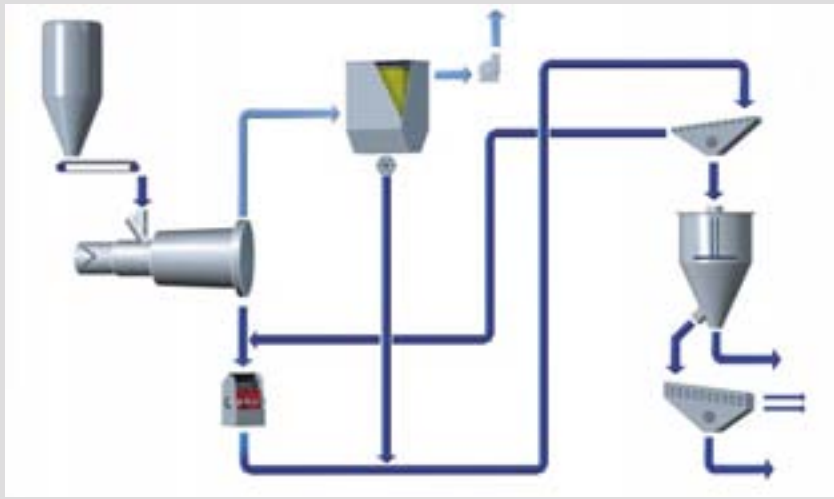

2

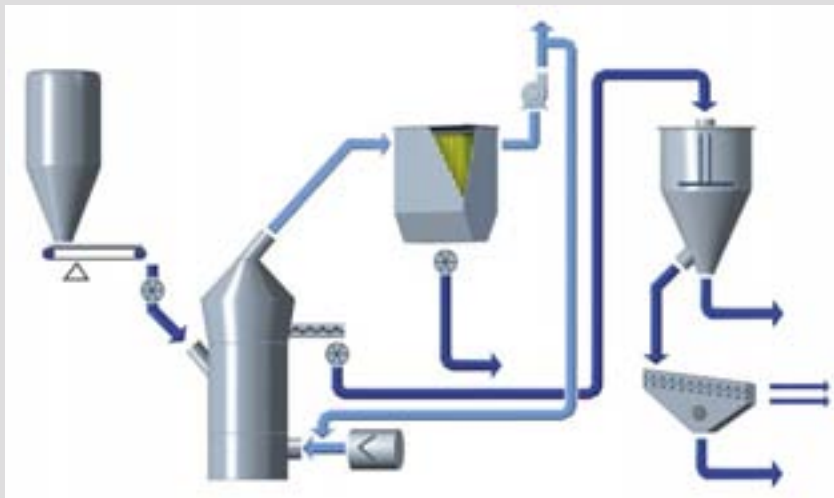

3

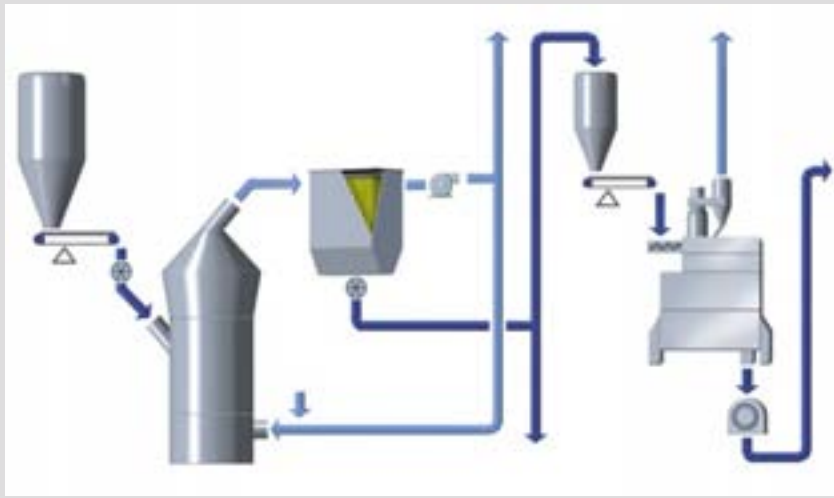

4

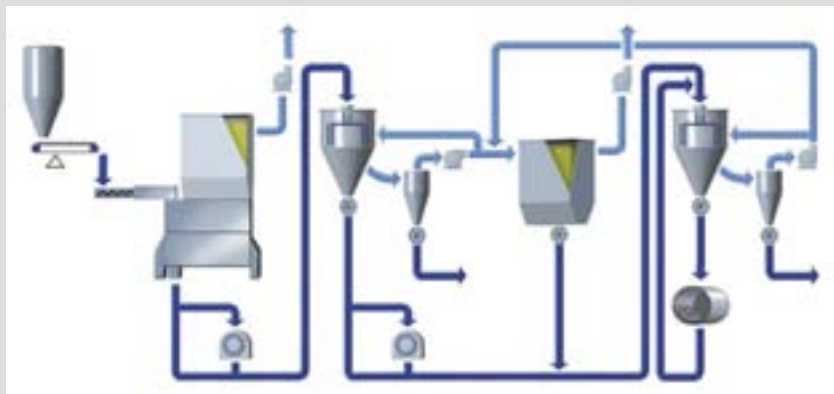

Our machines in lime works - the process variants

Crushed limestone

① Limestone lumps are dried in PFEIFFER Triplex dryers, crushed in fast-running mills, dedusted in PFEIFFER separators and separated in screening machines for the production of crushed limestone sand (0-0.5 mm - 0-4 mm). Limestone filler is produced as a coupled product.

The crushed limestone sand produced this way is primarily used in the building materials industry, limestone filler for road construction.

Limestone sand and pulverized limestone

② Limestone lumps are ground, dried and separated in PFEIFFER MPS vertical roller mills. The fineness of the pulverized limestone can be set within wide limits (0.02 mm - 4 mm). If requested the grits can be withdrawn from the grinding process, dedusted in downstream PFEIFFER separators and separated in screening machines to produce limestone sands (0.1 - 1.5 mm).

Pulverized limestones are primarily used as a filler or for flue gas desulphurization, limestone sands for the production of building materials.

White fine lime and lime hydrate

③ Quicklime lumps are ground and separated in PFEIFFER MPS vertical roller mills. The fineness of the white fine limes can be set within wide limits (0.06 mm - 0.1 mm). In downstream PFEIFFER lime hydrators white fine limes are processed by adding water thereby creating lime hydrate.

White fine lime is used for the production of limestone bricks and aerated concrete, lime hydrate for the production of plaster and mortar.

High-purity lime hydrate and building lime

④ In PFEIFFER lime hydrators quicklime lumps are converted to lime hydrate by adding water. In downstream PFEIFFER separators high-purity lime hydrate is separated from the grits. The grits are ground to target fineness in ball mills which operate in closed circuit with separators.

High-purity lime hydrate is primarily used in the chemical industry and for water conditioning.

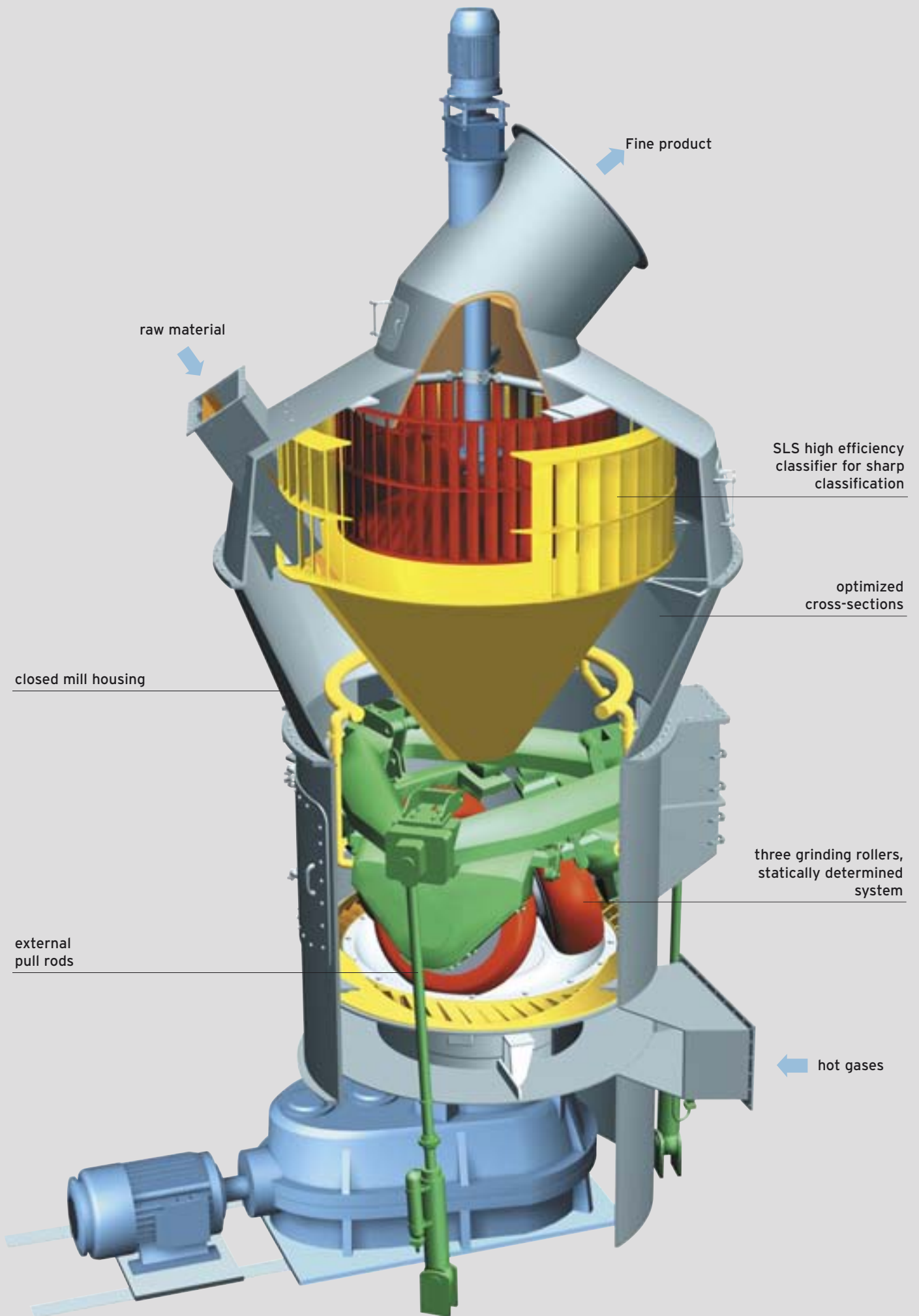

The PFEIFFER MPS vertical roller mill - the optimum machine for comminution

The solution to your problem

Grinding-drying of limestone to produce pulverized limestone and grinding of quicklime to produce white fine lime

throughput rate	3 - 100 t/h
target fineness	20 - 100 μm
feed size	10 - 80 mm
feed moisture	pit moisture
product moisture	< 0.5 %

Up to 60 % of the grits can be extracted as a coupled product.

The working principle

Three stationary grinding rollers roll on a slowly rotating grinding table. The material is drawn in between grinding roller and grinding track and ground by pressure and shear. The compression force required for the comminution of the material is generated by a hydro-pneumatic tensioning system.

The material is ground and conveyed by centrifugal force towards the stationary nozzle ring. Gases (air or hot

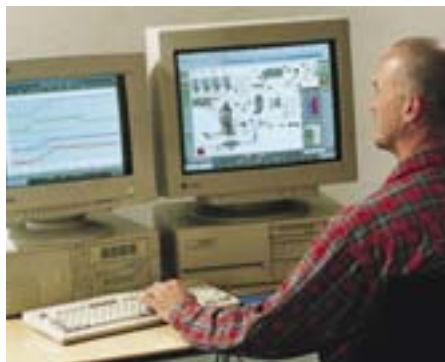

gases) flowing up through the nozzle ring mix with the material and carry it up to the classifier. In the separating zone a rotating separating wheel separates the ground and dried material into a fine finished product and grits. The grits fall back into the center of the grinding zone or are fully or partially extracted as a coupled product. The finished product leaves the classifier together with the gas stream and is separated in downstream cyclones or a filter unit.

The advantages

Low investment costs

MPS mills require few ancillary machines, no or little walled-in space, they operate dust-free and have a low noise level.

Low electric power consumption

The grinding principle and the high-efficiency classifier reduce the electric power consumption by up to 40 % compared with conventional ball mills.

Optimum utilization of process heat

MPS vertical roller mills allow an optimum utilization of the thermal energy of low-temperature process gases.

Maximum availability

Low specific wear rates, high-quality wear materials and progressive repair concepts reduce downtimes of MPS vertical roller mills to a minimum.

Favorable control behavior

High drying capacity, short retention times and remote control of the grinding pressure and the speed of the separating wheel allow MPS vertical roller mills to be operated fully automatically even with fluctuating raw material qualities.



MPS mill for the production of pulverized limestone and limestone sand

The PFEIFFER ball mill

The solution to your problem

Grinding of hydrate grits

throughput rate 1 - 60 t/h
target fineness 60 - 100 μm

The working principle

The material is fed into the ball mill through the neck bearing journals. Grinding balls grind it by impact and friction.

The ground material leaves the mill through discharge slots arranged around the mill tube.

Number, size and arrangement of the discharge slots depend on the mill size, the type of processed material and the requested target fineness.

Grinding fineness and grain size distribution of the finished product are determined by the cross-section of the discharge slots.

The advantages

Low electric power consumption

Fine material particles cannot be ground too finely due to a short grinding track and an adjustable retention time.

Adjustable grain size distribution

Product fineness and grain size distribution are adjustable by a variation of the cross-section of the discharge slots.

Maximum availability

Plain, robust design, wear-resistant lining, low maintenance



Doublehard ball mill with center discharge

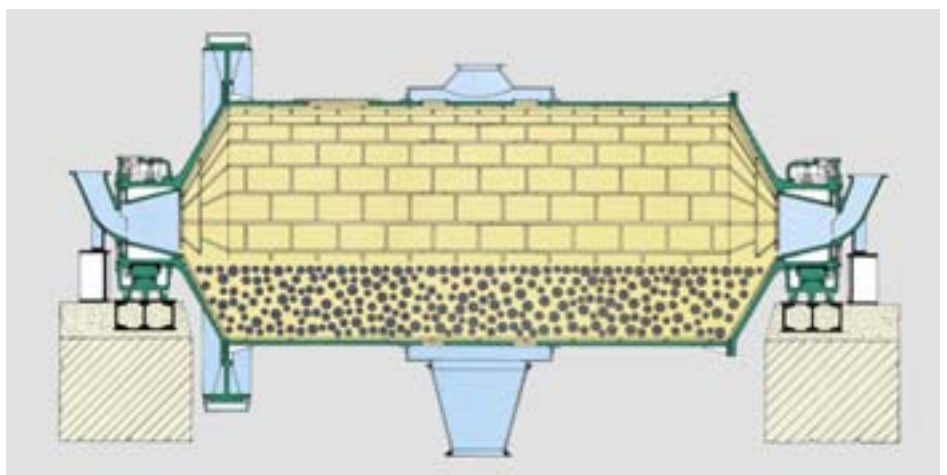

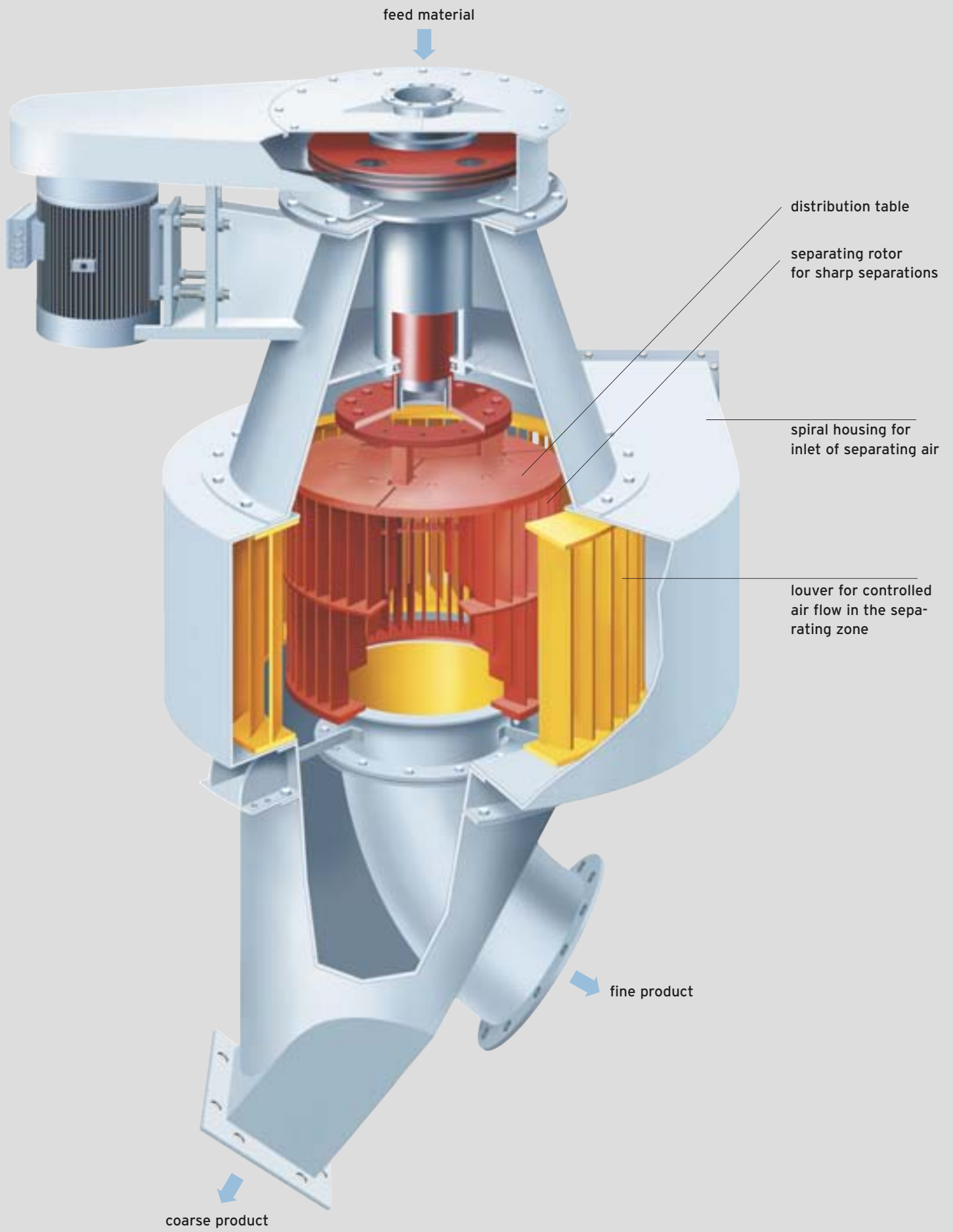

PFEIFFER separator - since 1886 well-known for its quality and economy

The solution to your problem

Dedusting of crushed limestone sand,
production of limestone filler,
white fine lime and lime hydrate

The distribution table air separator type SUT with constant speed

The cost-effective separator for the pro-
duction of primarily one target fineness,
typical target fineness 90 - 200 μm

The distribution table air separator type SUV with variable speed

Your solution when it comes to the
production of several target fineness
degrees.

The high-efficiency separator type SLV with variable speed

For ultra-sharp separation and the
production of high fineness degrees,
target fineness 10 - 90 μm
feed rate 1 - 200 t/h

The working principle

An air stream transports the material
into the separating zone where it is
separated into a fine product and a
coarse product. The coarse product is
always discharged through a cone, for
example for further processing. With
the SUT and SUV series the fine prod-



PFEIFFER high-efficiency separator SLV

uct is discharged through an integrated
cone, with the SLV series it is sepa-
rated in a downstream cyclone or filter.

The advantages

Sharp separation

Uniform product distribution in the
separating zone due to a central ma-
terial infeed;
pre-separation and post-separation as
a result of an optimum arrangement
of the louver.

Many and diverse applications

All separators can be used for sepa-
ration in one passage or in circuit
operation with a grinding plant.

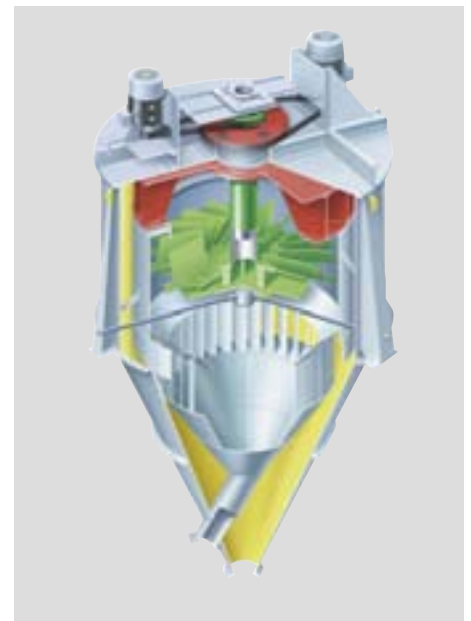

PFEIFFER distribution table separator SUV

No need for dust collection equipment

All distribution table air separators can
be operated without dust collection
equipment.

Long service life

Special linings protect our separators
from wear. We can offer partial or com-
plete linings made of steel, rubber, syn-
thetic or ceramic materials, depending
on the type and abrasiveness of the
processed material.

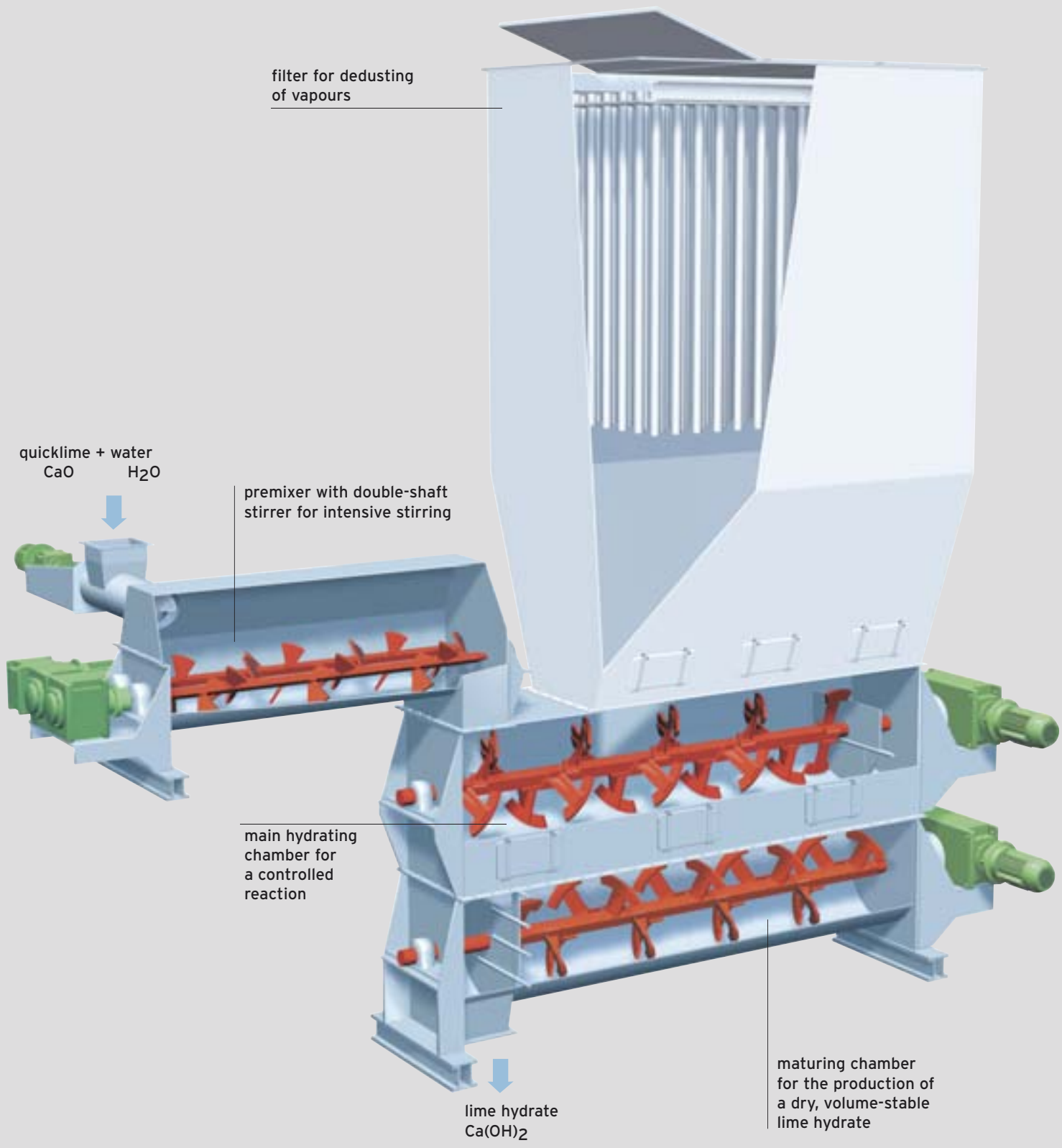

The PFEIFFER KLV lime hydrator - lime turns into hydrate

The solution to your problem

Production of lime hydrate from quicklime

product rate 1 - 60 t/h
 feed size 0 - 20 mm

Complete conversion of calcium oxide into calcium hydroxide.



lime hydrator with wet scrubber

The working principle

In the lime hydrator quicklime fines or quicklime lumps turn into lime hydrate (CA(OH)₂) after the addition of water at a temperature of approx. 100 °C.

The requested residual moisture of the hydrate is regulated by a temperature-controlled water supply and a variable material retention time.

Depending on the individual requirements the hydrator is designed as a one-stage machine or a multi-stage machine, with or without pre-mixer.

The vapors developing during hydration are dedusted. Filters or wet scrubbers are an integral part of the lime hydrator.

The advantages

Suitable for all types of quicklime

The PFEIFFER lime hydrator is capable of processing soft, medium or hard-burnt lime qualities.

High product quality

The water supply to the lime hydrator can be finely adjusted to suit the individual quicklime properties and guar-

antees the production of a completely hydrated finished product with a low residual moisture content, a high portion of fines and a low portion of agglomerates.

Fully automatic operation

The PFEIFFER hydrating machines can be operated fully automatically due to a gravimetric quicklime supply, a temperature-dependent water supply and a perfected measuring philosophy.



pre-mixer with double-shaft stirrer

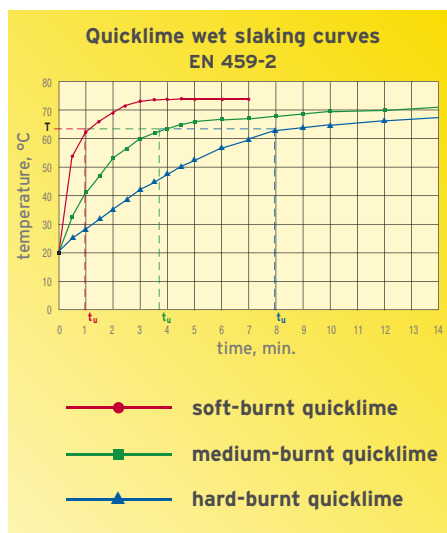

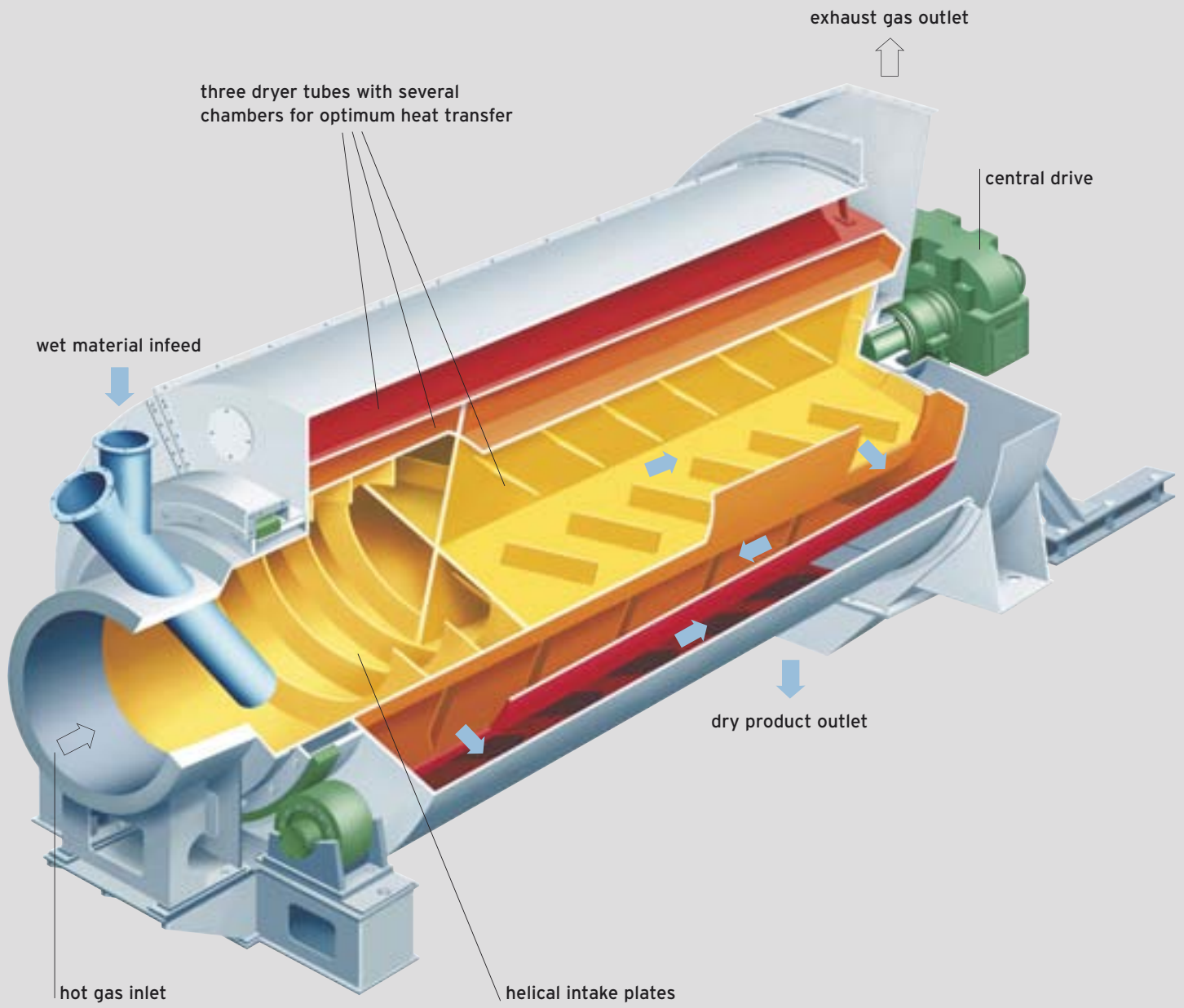

The PFEIFFER Triplex dryer

The solution to your problem

Drying of limestone

finished product rate	1 - 200 t/h
feed size	up to 150 mm
all usual feed moistures	
residual moisture	up to 0.1 %

The working principle

The Triplex dryer type TRT operates on the uniflow principle, i.e. material and hot gases flow in the same direction and pass through the dryer tubes from the center outwards.

The material to be dried is fed into the innermost tube, it passes through the dryer and is discharged through double pendulum flaps fitted to the dust jacket.

The residual moisture of the dried material is controlled by a regulation of the exhaust gas temperature and the dwell time of the material in the dryer.

The advantages

The hot gas is produced in a combustion chamber. For combustion either solid, fluid or gaseous fuels can be used. A utilization of process gases is possible as well.

The dryer exhaust gases are dedusted in a filter.

Low space requirement

As a consequence of its short design and the concentric arrangement of the dryer tubes the investment cost for buildings and foundations is low.

Short dryer start-up and shut-down times

No ceramic lining is required, the dryer is made of temperature-resistant steel plates.



Triplex dryer with hot gas generator

Careful material treatment

The material is treated with care. It will not overheat due to the uniflow principle.

Low thermal energy consumption

The small dryer surface and the uniflow principle result in very low heat loss by radiation.

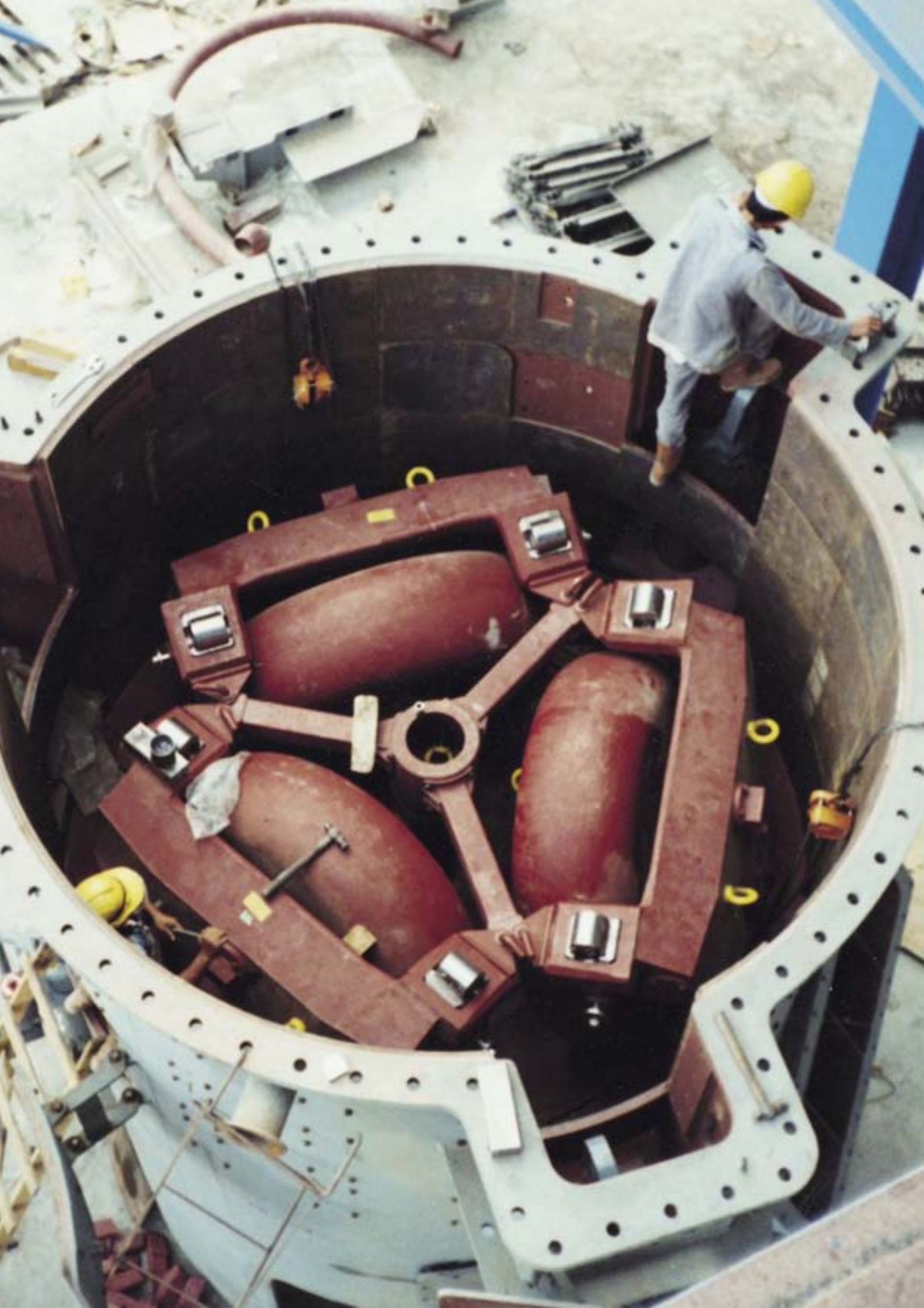

PFEIFFER services - you can always count on us

Test station

In our test station raw materials are tested for their processing qualities, and in our laboratories these raw materials are characterized by taking all the relevant norms and standards into account.

For these tests pilot plants with machines from our manufacturing program are available for throughput rates from 0.5 to 10 t/h. The results of the tests serve as a basis for selecting the suitable process for a given application and for the machine and process dimensioning.



Consultation

We are competent in designing and planning not only new plants but also plant conversions, in upgrading and modernizing existing plants, in maintenance and repair, the selection of suitable wear materials and in answering all process related questions.

Manufacture

We have our own mechanical workshops and a foundry. All phases of our product manufacture are carefully planned. The quality of our products

is systematically supervised and documented pursuant to the quality management system of DIN ISO 9001.

Spare parts service

Original spare parts guarantee that your plant will operate economically even many years after its erection. Take advice from our experienced engineers. Our electronic wear analysis for the grinding elements of the MPS mill records the actual wear progress and allows a selective spare parts inventory and maintenance.

Erection and commissioning

Experienced engineers and supervisors are available for erection and commissioning and for the training of your operating and maintenance personnel.





GEBR. PFEIFFER

Progress is our tradition

Gebr. Pfeiffer SE
Barbarossastraße 50-54
67655 Kaiserslautern/Germany
Phone: +49 631 4161 0
Fax: +49 631 4161 290
E-mail: kv-p@gpse.de
Internet: www.gpse.de